

SADLAK INDUSTRIES LLC

Nadeau Industrial Park • 712 Bread & Milk St. Unit 7 • P.O. Box 202 Coventry, CT 06238
Tel. (860) 742-0227 • Fax. (860) 742-4244 • Email sales@sadlak.com • Website www.sadlak.com

TUTORIAL FOR USING THE SADLAK RECEIVER GROOVE INSPECTION KIT

The Inspection kit is a simple tool to help troubleshoot scope mounting problems since some problems may occur as a result of an out-of-spec receiver groove. If you are having windage or elevation problems, start by using the receiver inspection to determine your individual dimensions and make sure your mount is correctly installed..

The actual kit includes instructions and precision pins used to inspect the receiver to determine if the left side groove is within USGI specifications.

For accurate results, follow the instructions carefully.



Precision Ground Inspection Pins Included in Kit

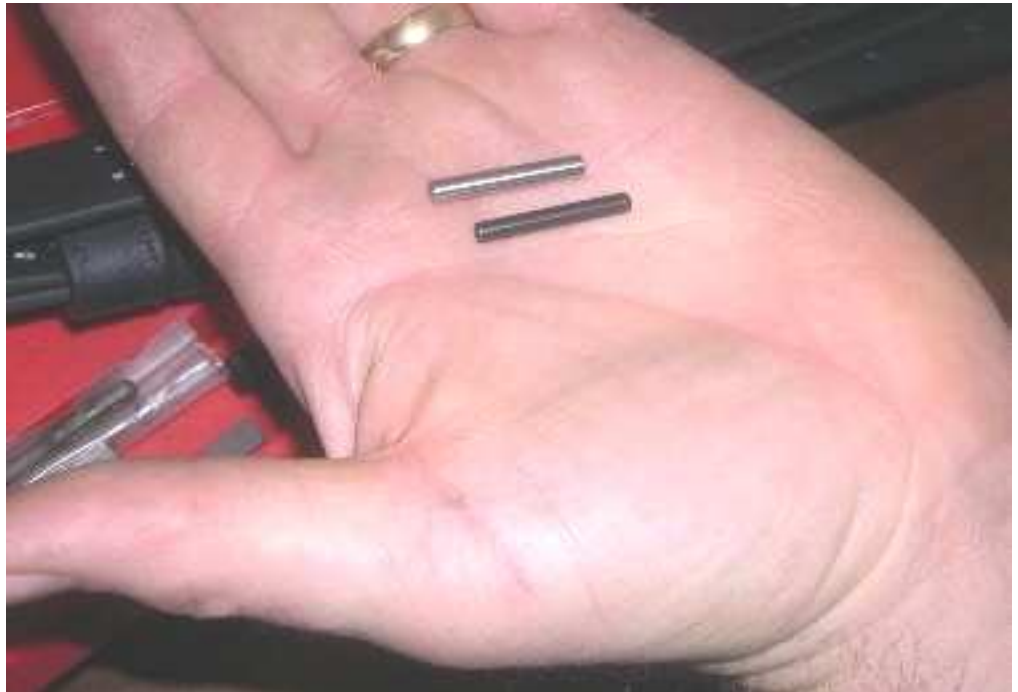

These pins are used to accurately measure the left side receiver groove width to determine if it meets USGI specifications.

Inspecting the groove is useful for trouble-shooting problems that may occur with the scope mount installation. The problem could be caused by an out-of-spec groove on the M1A receiver.

The groove has tapered side walls and must be measured over a round pin to accurately determine the width.

SADLAK INDUSTRIES LLC

Nadeau Industrial Park • 712 Bread & Milk St. Unit 7 • P.O. Box 202 Coventry, CT 06238
Tel. (860) 742-0227 • Fax. (860) 742-4244 • Email sales@sadlak.com • Website www.sadlak.com

TOOLS NEEDED FOR ACCURATE RESULTS

A 6" Dial Caliper (Good) or a 2" Micrometer (Best) will be required.

6" Digital Caliper with Depth measurement rod

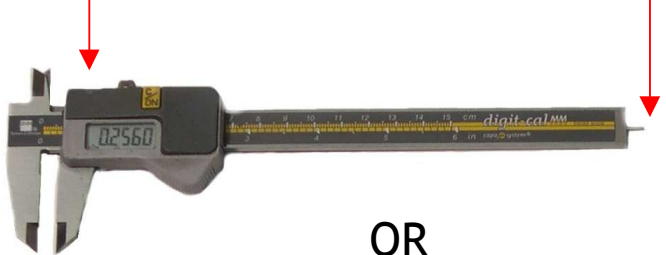

OR

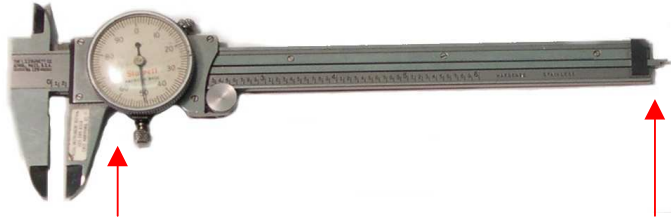

6" Dial Caliper with Depth measurement blade

2" Dial Micrometer



Other helpful, but non-essential tools, that may be used during the inspection include a magnifying glass and an eye loop



SADLAK INDUSTRIES LLC

Nadeau Industrial Park • 712 Bread & Milk St. Unit 7 • P.O. Box 202 Coventry, CT 06238
Tel. (860) 742-0227 • Fax. (860) 742-4244 • Email sales@sadlak.com • Website www.sadlak.com

STEP 1

Select the appropriate sized pin. The following diagrams will help you determine which size pin works best for your application.

The pin should rest on the angled face inside the groove (Fig. 3a) without touching the groove bottom (Fig. 3b) or contacting the corners on the widest part of the groove (Fig. 3c).

CORRECT
FIG. 3a

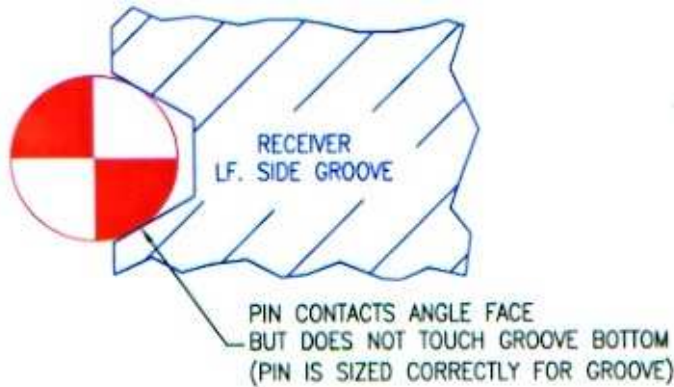

INCORRECT
FIG. 3b

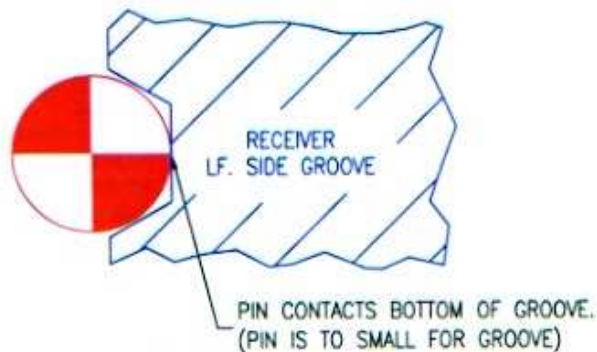

INCORRECT
FIG. 3c

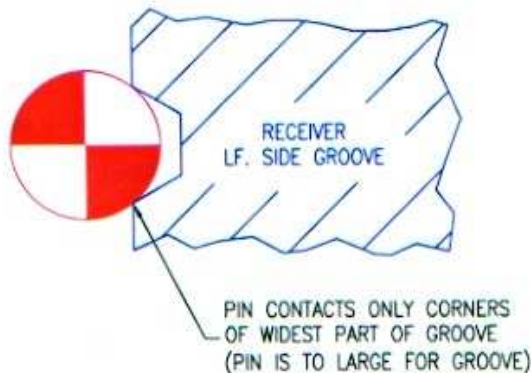

Often the small pin works best when the groove depth (Dim. 2) is less than .055" or the groove top width (Dim. 4) is less than .135. - See Fig. 2 diagram on page 10 for Dim. 2 and Dim. 4 locations.

SADLAK INDUSTRIES LLC

Nadeau Industrial Park • 712 Bread & Milk St. Unit 7 • P.O. Box 202 Coventry, CT 06238
Tel. (860) 742-0227 • Fax. (860) 742-4244 • Email sales@sadlak.com • Website www.sadlak.com

Helpful Hint: First measure Dim. #2 (Groove Depth) and Dim. #4 (Groove Top Width) to help determine the best pin size. See Fig. 2 diagram on page 10 for Dim. 2 and Dim. 4 locations.

The following are two quick methods to determine best pin size:



Method 1: Good

Use a flashlight or hold up to a light to see if the pin is contacting the groove bottom.

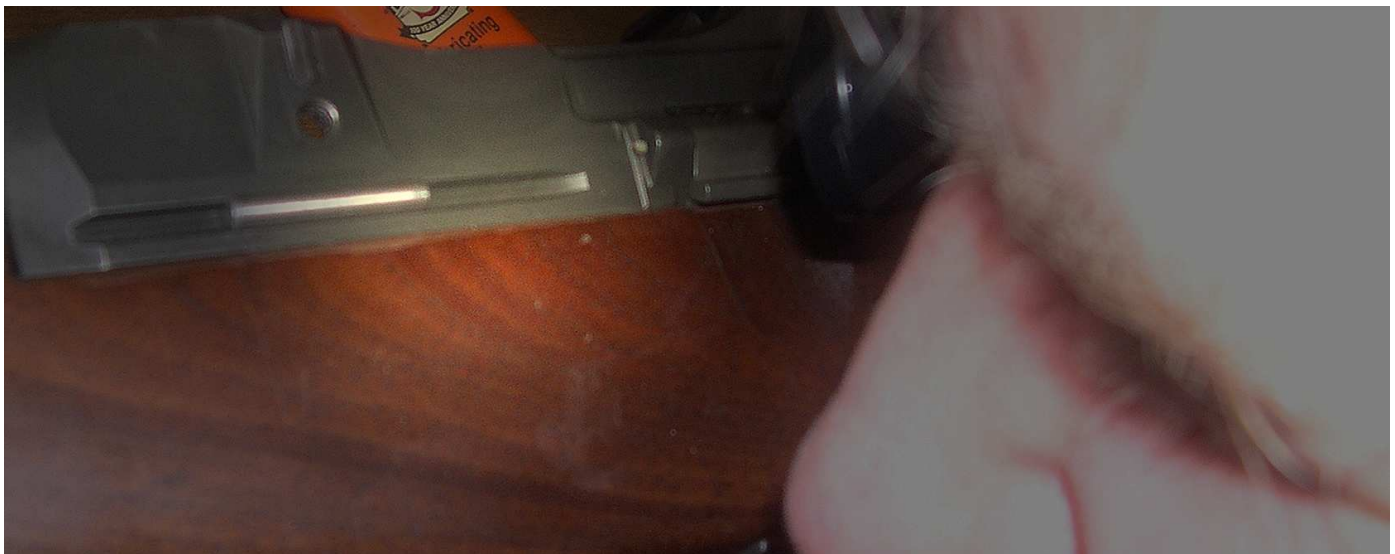

SADLAK INDUSTRIES LLC

Nadeau Industrial Park • 712 Bread & Milk St. Unit 7 • P.O. Box 202 Coventry, CT 06238
Tel. (860) 742-0227 • Fax. (860) 742-4244 • Email sales@sadlak.com • Website www.sadlak.com



Method 2: Better

Cut a small strip of paper no greater than the width of the groove bottom. When cutting the strip, include a larger tab as shown for ease of holding the strip.

Place the paper strip on the groove bottom before placing the pin in the groove.

If you can pull the paper strip out from under the pin, you will know that the pin is not in contact with the bottom of the groove.



SADLAK INDUSTRIES LLC

Nadeau Industrial Park • 712 Bread & Milk St. Unit 7 • P.O. Box 202 Coventry, CT 06238
Tel. (860) 742-0227 • Fax. (860) 742-4244 • Email sales@sadlak.com • Website www.sadlak.com

The best way to hold the pin in place when measuring is to use 1 or 2 rubber bands near each end of the pin.



A paperclip or similar device can be used to properly tighten the rubber bands so the pin is held tightly in place.

Accurate measurements can now be taken on the unobstructed pin center.



SADLAK INDUSTRIES LLC

Nadeau Industrial Park • 712 Bread & Milk St. Unit 7 • P.O. Box 202 Coventry, CT 06238
Tel. (860) 742-0227 • Fax. (860) 742-4244 • Email sales@sadlak.com • Website www.sadlak.com

FIG. 1

LEFT SIDE GROOVE CROSS-SECTION

VIEW LOOKING TOWARD FRONT SIGHT.

CROSS-SECTION AT CENTER OF LEFT-SIDE #12-32 THREADED HOLE

Steps 2, 3, and 4 that follow are used to determine Dimension #1 Groove Width

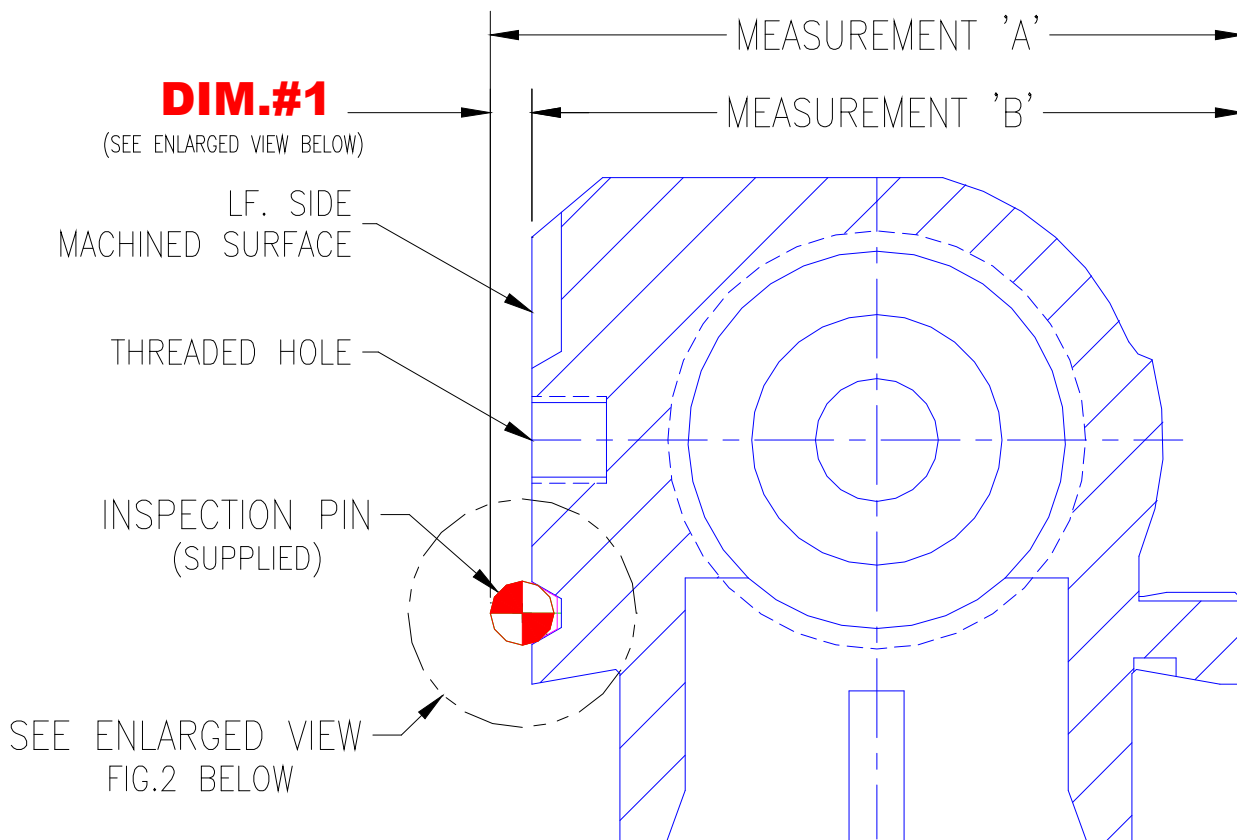

FIG. 1

SADLAK INDUSTRIES LLC

Nadeau Industrial Park • 712 Bread & Milk St. Unit 7 • P.O. Box 202 Coventry, CT 06238
Tel. (860) 742-0227 • Fax. (860) 742-4244 • Email sales@sadlak.com • Website www.sadlak.com

STEP 2

Dimension 1

Using a 6" Dial Caliper (Good) or a 2" Micrometer (Best), find measurement "A".

Note: Measurements "A" and "B" shown in Step 2 and Step 3 must be taken at the same cross-section location shown in Fig. 1 (Above)



Measurement A

With Pin inserted in the receiver left side groove, measure receiver width over the pin.

Shown here using a 2 inch Micrometer

View facing buttstock



Alternate Tools

Measurement A

Shown here using a 6 inch Caliper

View facing muzzle

SADLAK INDUSTRIES LLC

Nadeau Industrial Park • 712 Bread & Milk St. Unit 7 • P.O. Box 202 Coventry, CT 06238
Tel. (860) 742-0227 • Fax. (860) 742-4244 • Email sales@sadlak.com • Website www.sadlak.com

STEP 3

Remove Pin from Groove to find Measurement “B”



Measurement B

2-Inch Micrometer measuring receiver width with the pin removed from the receiver left side groove

View facing buttstock

Alternate Tools



Measurement B

6-Inch Caliper measuring receiver width with the pin removed from the receiver left side groove

View facing muzzle

STEP 4

Calculate Dim. #1 (Pin Height Above Left Side Surface shown in Fig. 1 above) by subtracting Measurement “A” from Measurement “B”

SADLAK INDUSTRIES LLC

Nadeau Industrial Park • 712 Bread & Milk St. Unit 7 • P.O. Box 202 Coventry, CT 06238
Tel. (860) 742-0227 • Fax. (860) 742-4244 • Email sales@sadlak.com • Website www.sadlak.com

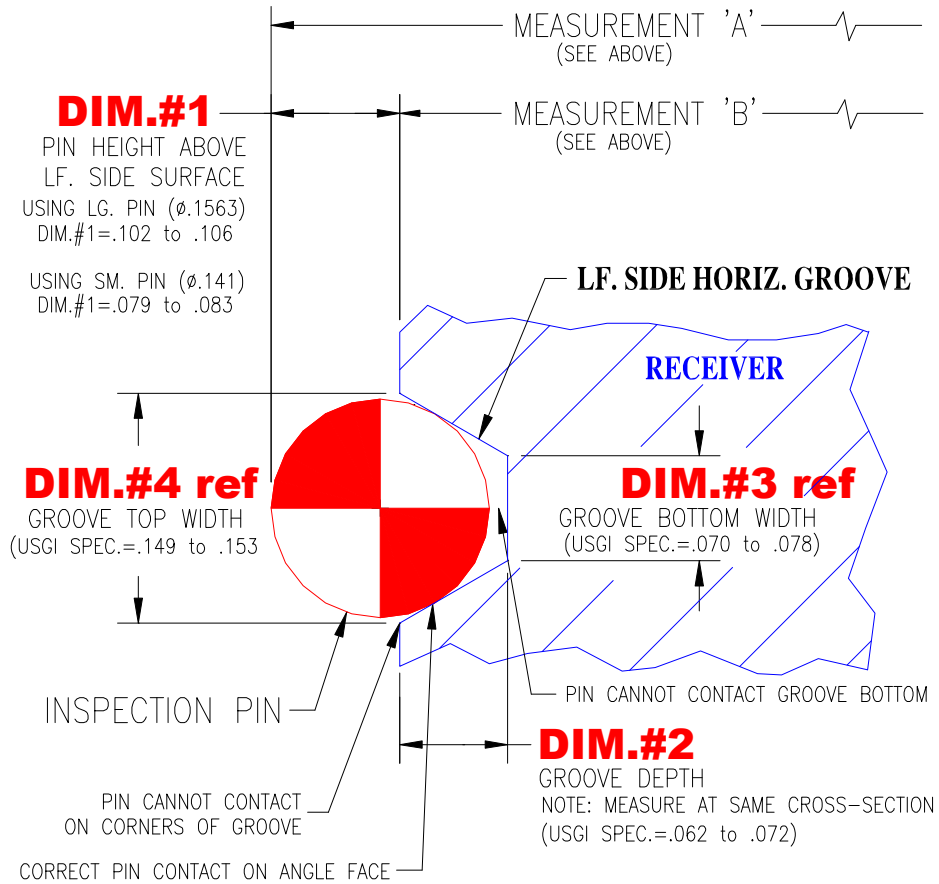

FIG. 2

ENLARGED LEFT SIDE GROOVE

Reference this drawing for Steps 5, 6, and 7

SADLAK INDUSTRIES LLC

Nadeau Industrial Park • 712 Bread & Milk St. Unit 7 • P.O. Box 202 Coventry, CT 06238
Tel. (860) 742-0227 • Fax. (860) 742-4244 • Email sales@sadlak.com • Website www.sadlak.com

STEP 5

Find Dim. #2 (Groove Depth) by measuring the depth of the groove using a 6" Dial Caliper (Good) or Depth Micrometer (Best) - See Fig. 2

Measure depth at the same cross-section as Step 2 above.

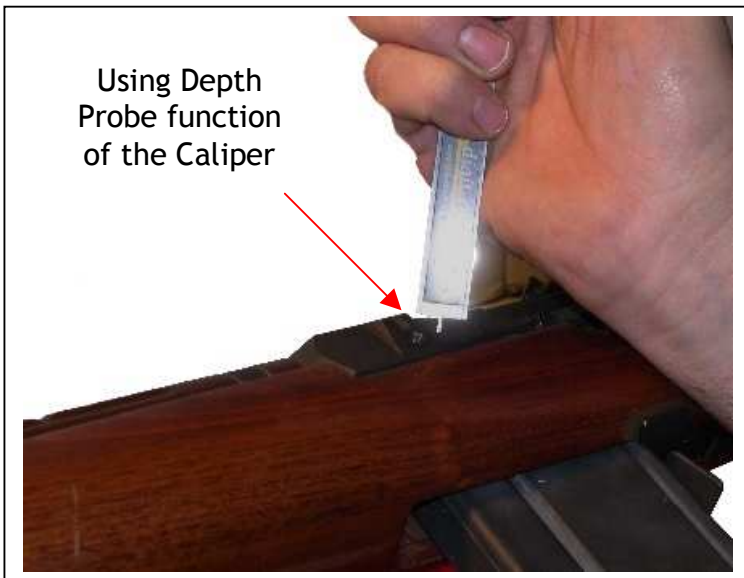

2nd view showing use of Depth Probe function of the Caliper

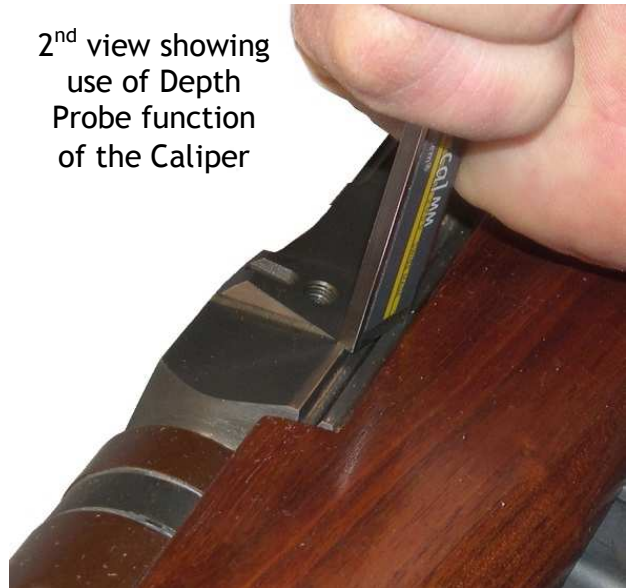

Dim. #1 (Pin Height above left side surface) and Dim. #2 (Groove Depth) are the **two most critical dimensions.**

The USGI spec for Dim. #2 (Groove Depth) is .062 to .072. If Dim. #2 is under .050, there is a high probability that custom fitting will be required.

Because the design of the Sadlak scope mount allows for a high degree of adaptability, if the depth of Dim. #2 (Groove Depth) is within .055 to .075, there is a good chance that a Sadlak scope mount will fit your receiver correctly.

SADLAK INDUSTRIES LLC

Nadeau Industrial Park • 712 Bread & Milk St. Unit 7 • P.O. Box 202 Coventry, CT 06238
Tel. (860) 742-0227 • Fax. (860) 742-4244 • Email sales@sadlak.com • Website www.sadlak.com

STEP 6

Groove Bottom Width (Dim. #3) and Groove Top Width (Dim. #4)

Find Dim. #3 and Dim. #4 using a 6" Dial Caliper.

Note: These dimensions are difficult to measure precisely due to small corner radius and/or corner breaks but they are still a good reference when combined with Dim. #1 and Dim. #2

Do your best to get the measurements to a theoretical sharp corner



Using the 6 Inch digital caliper to measure Dim. #3 (Groove Bottom Width)



This is one of the measurements where the magnifying tool can be usefully employed.



This photo illustrates determining Dim. #4 (Groove Top Width) using the 6 Inch Digital Caliper

NOTE: Dim. #3 (Groove Bottom Width) and Dim. #4 (Groove Top Width) are less critical than Dim. #1 and Dim. #2 in determining if the receiver left side groove is within USGI specs.

SADLAK INDUSTRIES LLC

Nadeau Industrial Park • 712 Bread & Milk St. Unit 7 • P.O. Box 202 Coventry, CT 06238
 Tel. (860) 742-0227 • Fax. (860) 742-4244 • Email sales@sadlak.com • Website www.sadlak.com

STEP 7

If Dim. #1 and Dim. #2 are within dimensions shown below, the left side groove is made to USGI Specifications.

Dim. #1 - Pin Height Above Left Side Surface
 Using Large Pin (0.1563) - Dim. #1 = .102 to .106
 Using Small Pin (0.1406) - Dim. #1 = .079 to .083

Dim #2 - Groove Depth
 USGI Spec = .062 to .072

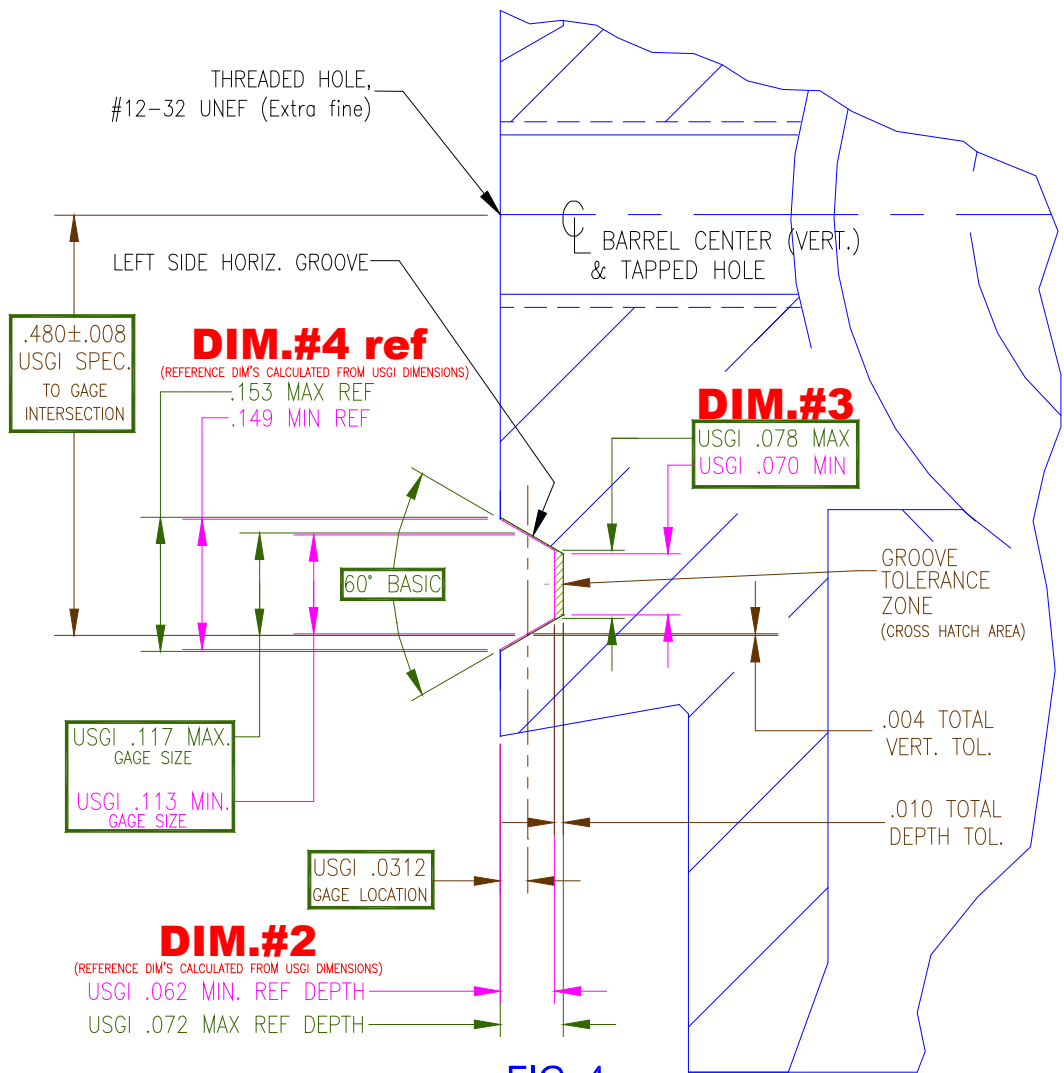

FIG. 4

LEFT SIDE GROOVE CROSS-SECTION

VIEW LOOKING TOWARD FRONT VIEW. CROSS SECTION AT CENTER OF LEFT SIDE #12-32 THREADED HOLE.

SADLAK INDUSTRIES LLC

Nadeau Industrial Park • 712 Bread & Milk St. Unit 7 • P.O. Box 202 Coventry, CT 06238
 Tel. (860) 742-0227 • Fax. (860) 742-4244 • Email sales@sadlak.com • Website www.sadlak.com

MEASUREMENT WORKSHEET

CUSTOMER NAME: _____

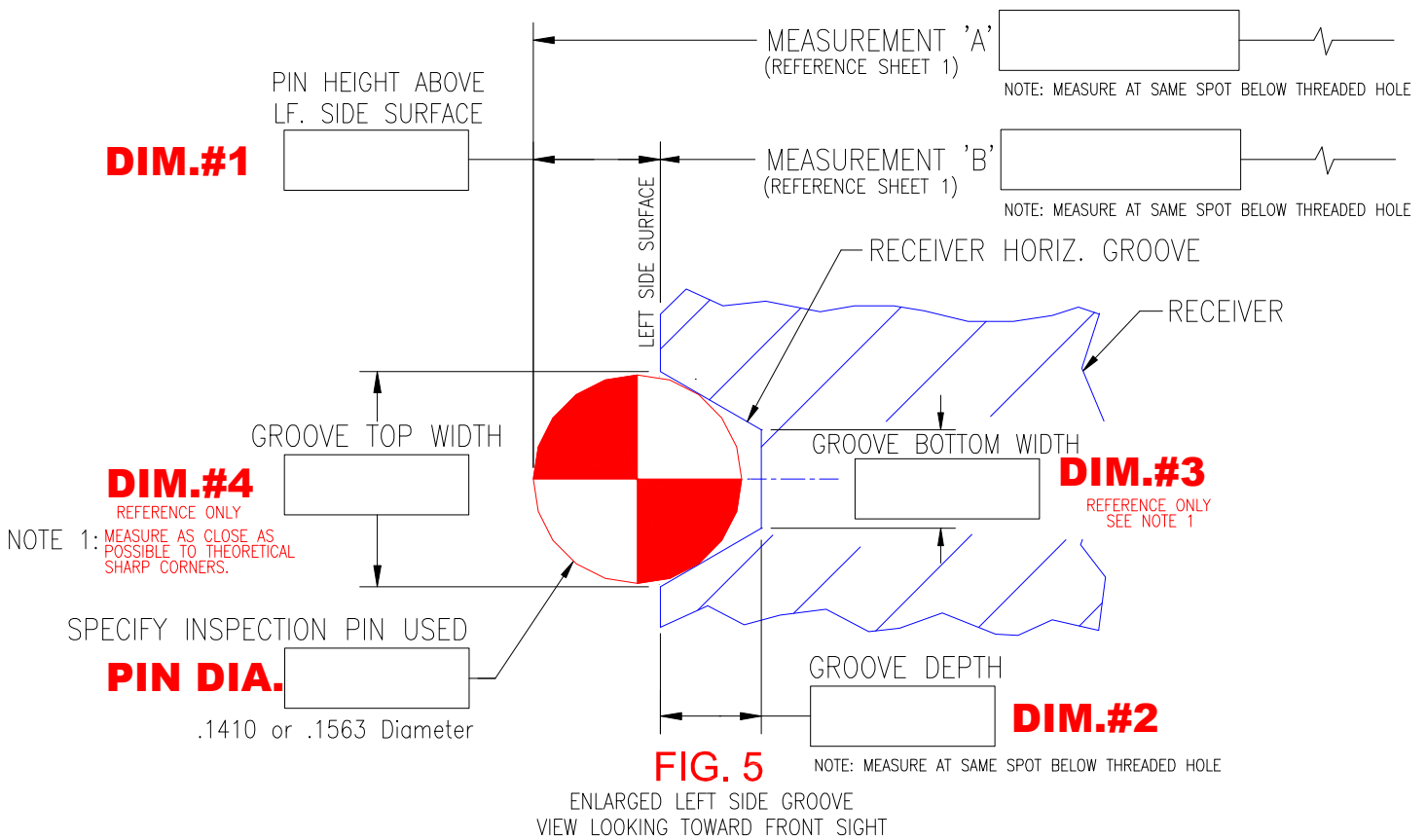

MEASURING INSTRUMENT USED: _____

Note: Using a 2" micrometer will be more accurate for obtaining Measurements A & B. A 6" Dial Caliper is the next best option. Dim.#2 groove depth is best measured with 6" dial caliper with depth probe. Remember to make all measurements at the same spot below threaded hole.

SADLAK INDUSTRIES LLC

Nadeau Industrial Park • 712 Bread & Milk St. Unit 7 • P.O. Box 202 Coventry, CT 06238
Tel. (860) 742-0227 • Fax. (860) 742-4244 • Email sales@sadlak.com • Website www.sadlak.com

After completing the inspection and filling out the form on Page 14, please fax both pages (14 and 15) to us at (860) 742-0227. Alternately, you may email or regular USPS the results to us making sure to include all of the information requested on both pages.

For email, please use sales@sadlak.com

For USPS regular mail, please use Sadlak Industries LLC, PO Box 202, Coventry, CT 06238-0202

CUSTOMER SELF-INSPECTION FORM

AFTER COMPLETING SELF-INSPECTION PROCESS PER INSTRUCTIONS,
FILL-OUT BOXES BELOW AND FAX TO 860-742-4244.

DATE:

NAME:

ADDRESS:

TEL:

EMAIL:

RECEIVER MFG:

RECEIVER S/N:

PURCHASE DATE:

Approx. date for new purchase only

COMMENTS: